



**WINDOOR CRAFT**  
Design and Production

**WINDOOR CRAFT**

**DESIGN AND PRODUCTION**



# ABOUT US

## DESIGN DOORS AND WINDOWS, JUST DRAG & DROP

Window Craft was Mainly aimed at the window industry, it created the “new world of windows industry software”.

According to the different requirements of different door and window enterprises for window structure, a set of automatic material calculation and optimization system is developed.

We have established a good and stable customer relationship with many well-known enterprises at demestic and abroad.

Window Craft gradually formed a strong talent and technology advantages. In particular, we have developed a rapid drawing, rapid material calculation system, and two major formulas. It solves the two big pain points of high cost and high error rate of manual calculation. It provides a set of optimization software for window enterprises to get through the intelligent calculation software of dealers and manufacturers.



# DO YOU WANT SOLUTIONS

# FOR YOUR UPCOMING BUSINESS?

Window Craft has a wide range of applications.

To meet with different kind of customers with different requirement, depending on the material they used, we added special features for each material type.

So it could be used for designing and making uPVC window door, aluminum window door, and wood window door.

Almost of all platform is supported, less is more

With experience of more than 10 years, window craft team delivers solutions to windows and doors industry all over the world.



# MAKE THE DESIGN EASY

## JUST 3 EASY STEPS

### SELECT & CLICK

Our software is very easy to use, we could choose the design tools by selecting and clicking. A wide range of rectangular and non-rectangular shapes design, mullion can be rotated toward any direction, almost any shape can be customized easily

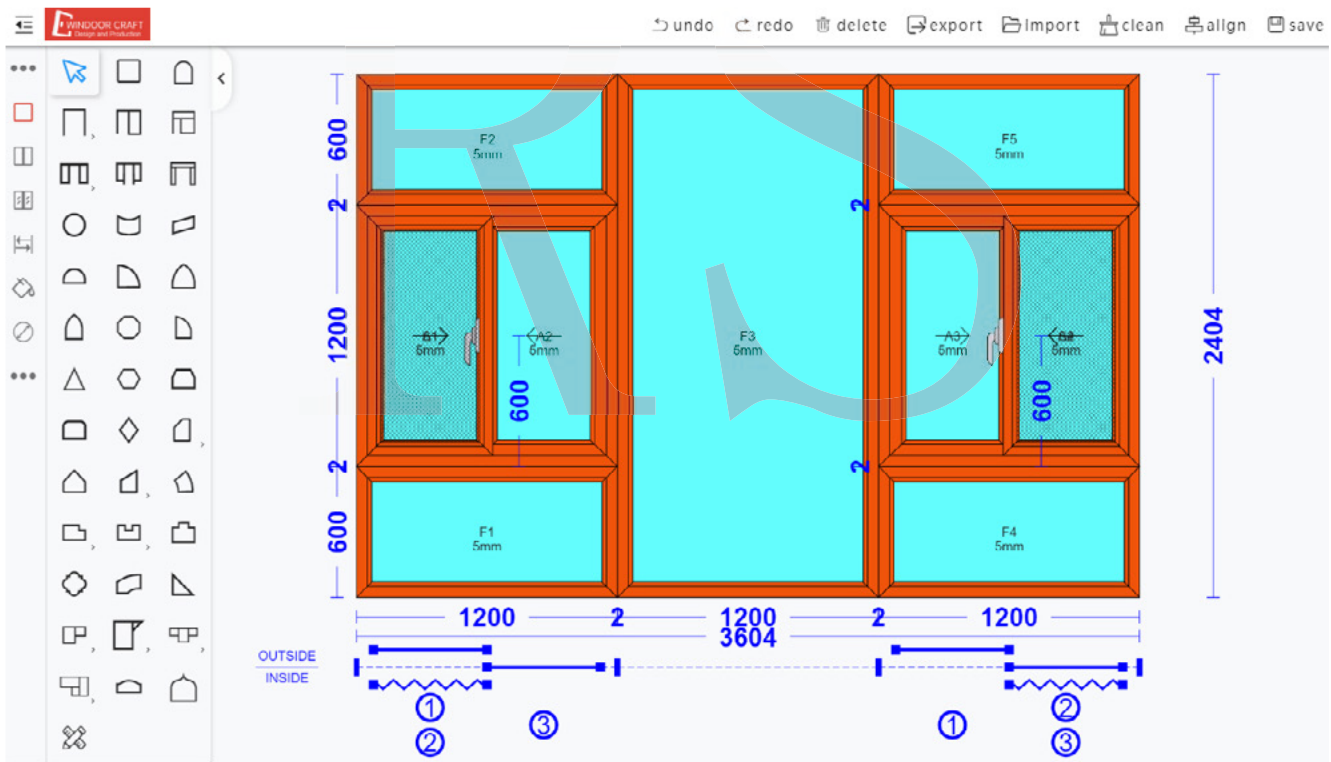

# DRAG & DROP

We could drag and drop any component to create a unique frame, mullion, sash, and more-even adjust item sizes to find the perfect fit.

Use the mouse to draw any size of windows, drag the left mouse button horizontally or vertically to create corresponding mullions, then add a sash. finish designing windows and doors just in a few seconds.

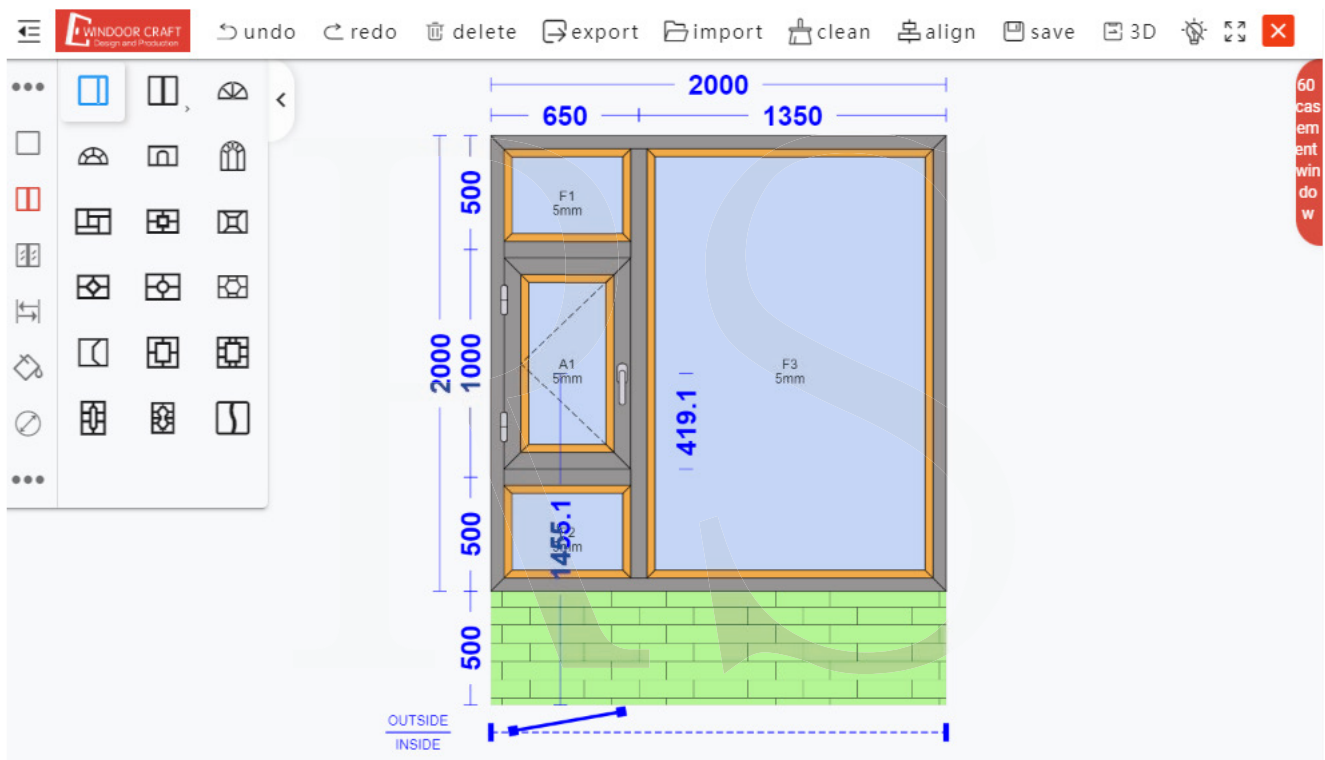

# PRINT & SHARE

Use our printing feature to generate a range of professional reports including client's quotations, dealer's price and bill of materials.

You can export it to PDF file or share link to your customers directly.

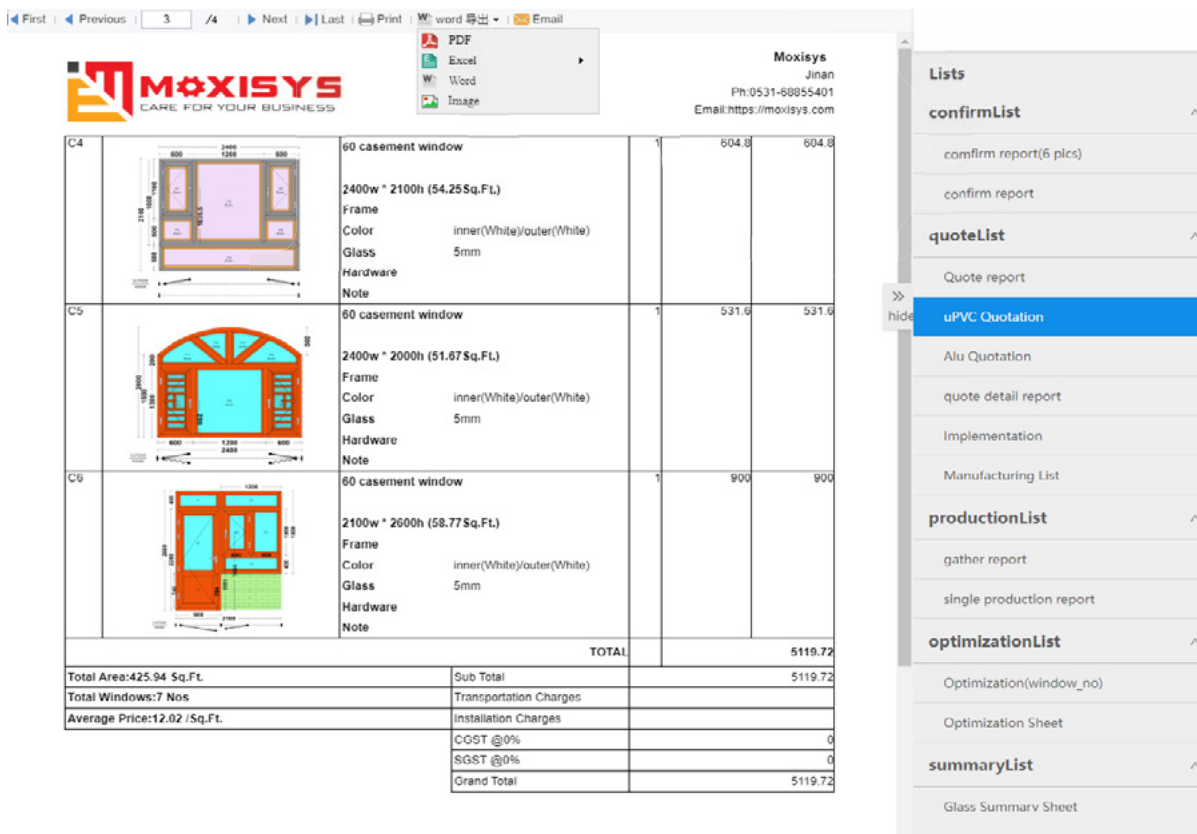
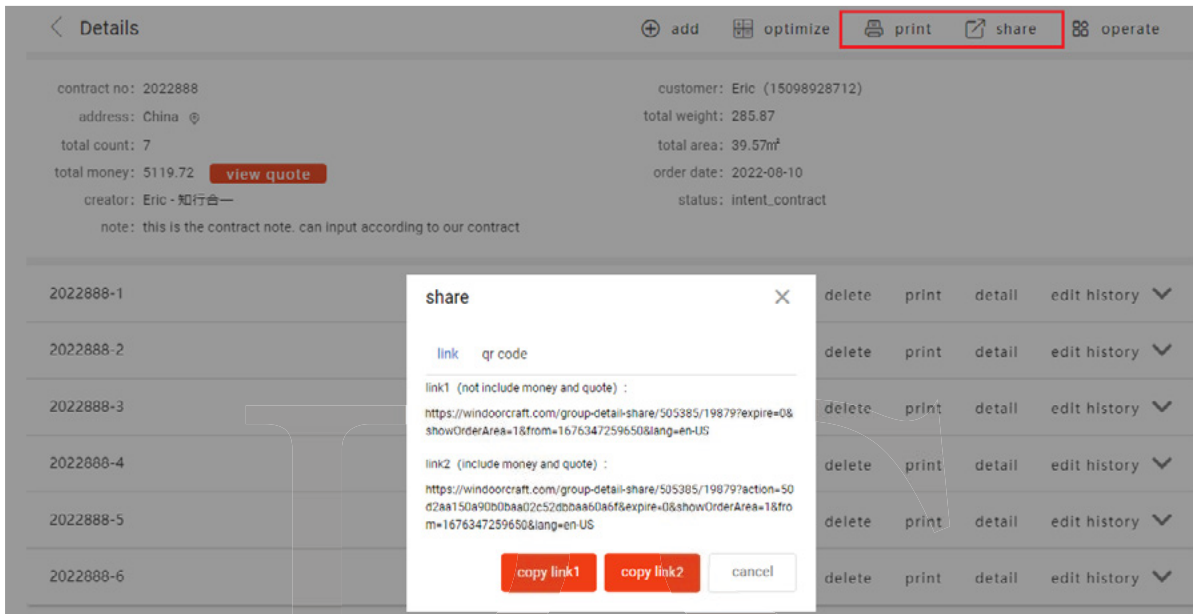

# ALMOST EVERYTHING CAN BE DRAGGED



## DRAG FRAME

Drag frame to transform shape on the fly, any edge of frame can be dragged to change size or shape of frame. it's so easy to operate, even child can get a hang of it very quickly.

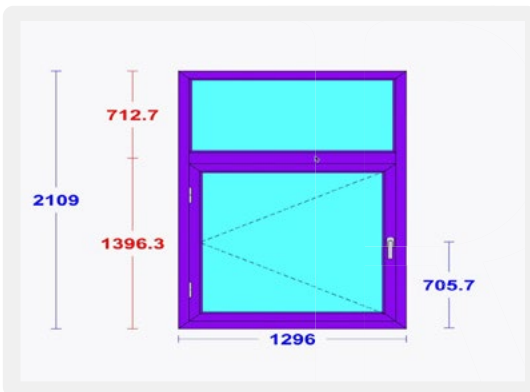

## DRAG MULLION

It can be dragged to arc shape on the fly, even can be rotated freely. fenestration can be tweaked easily by this way.

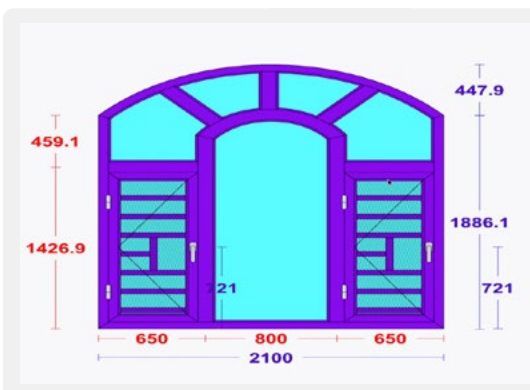

## DRAG HANDLE

Drag frame to transform shape on the fly, any edge of frame can be dragged to change size or shape of frame. it's so easy to operate, even child can get a hang of it very quickly.



# 8 TOOLS KIT MORE THAN 100 TOOLS

MAKE DESIGN MORE EASIER

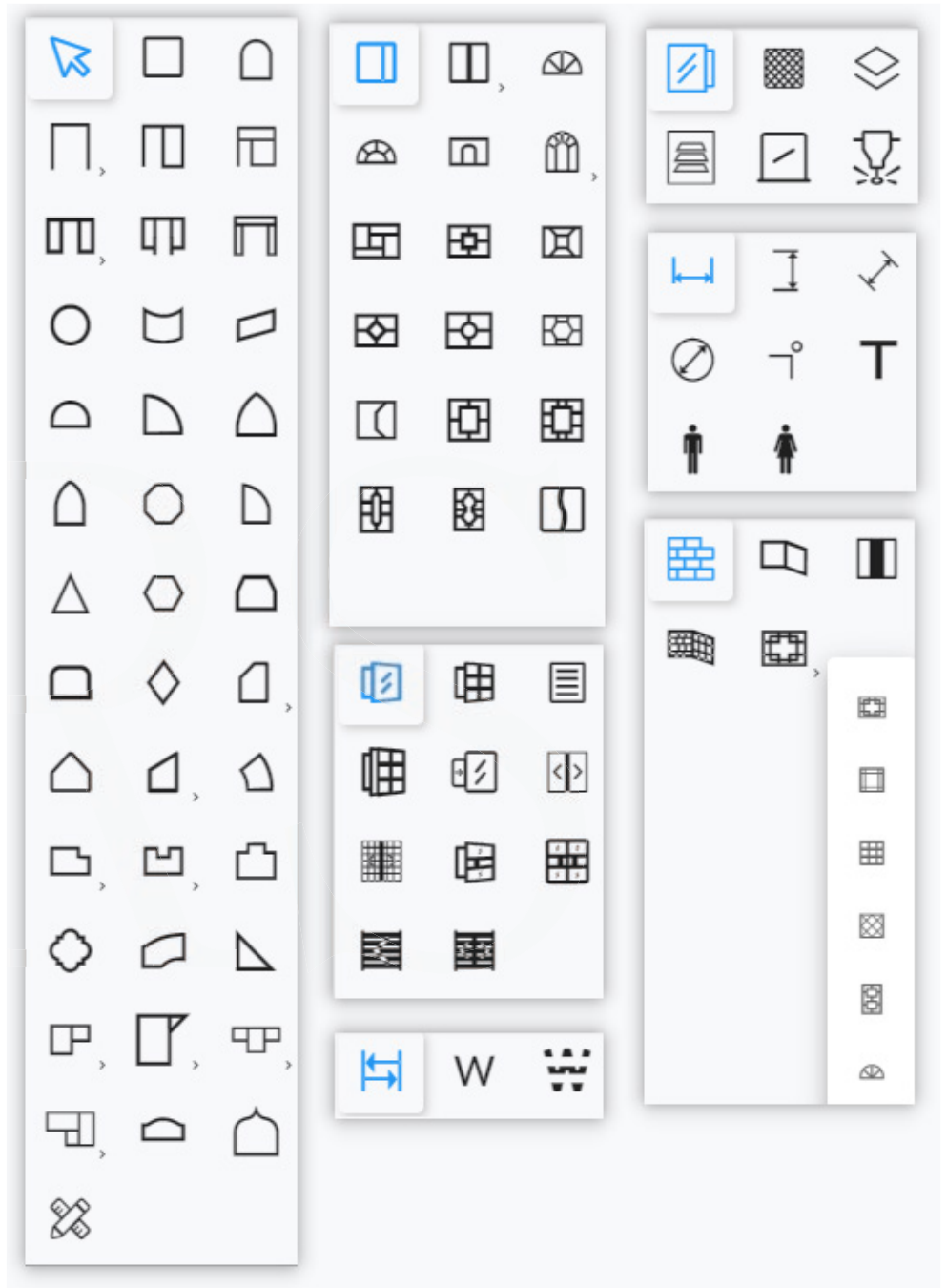
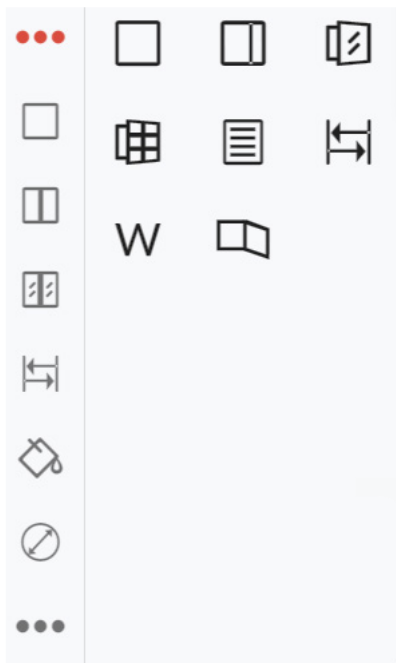



# GENERATE 3D MODEL AUTOMATICALLY

WHAT YOU SEE IS WHAT YOU GET, STUNNING DESIGN CAN BE CREATED EASILY

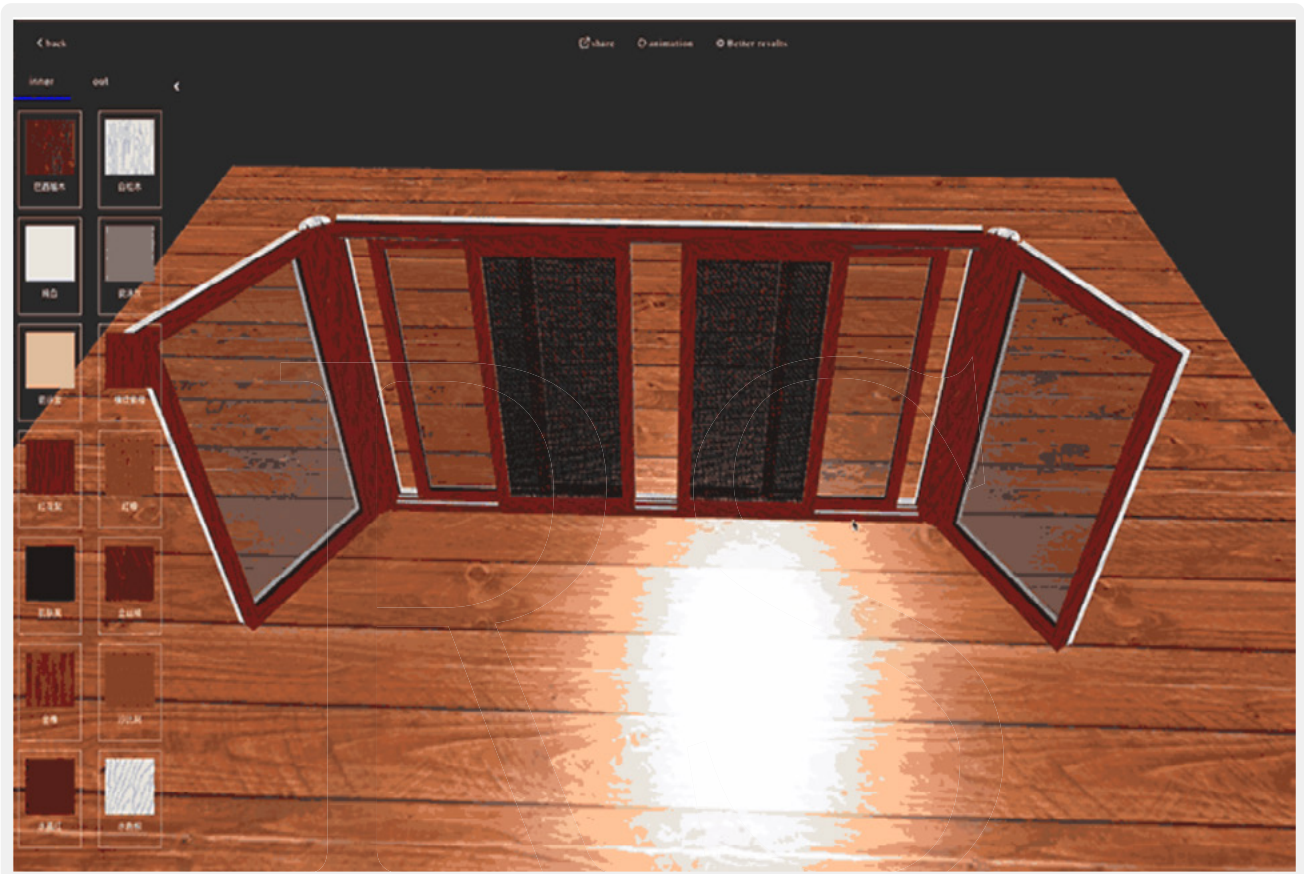

# REAL PHOTO MATCH

LET YOUR CLIENTS GET WHAT HE SEE

we could take some real pictures from our client's site, upload to the software and match our designed windows to show our clients the real effect.

Outstand among your competitors!

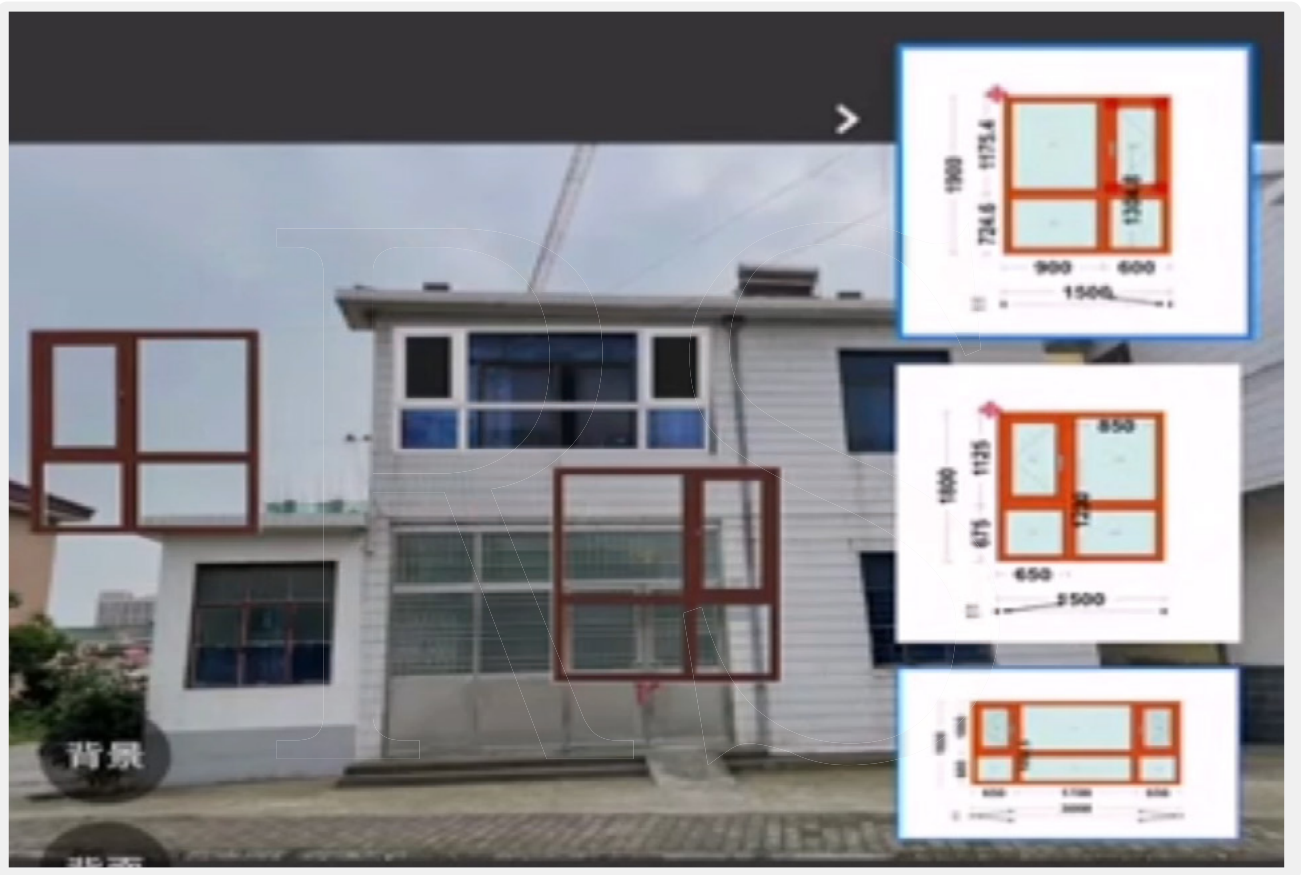

# ONLINE WORKING

CREATE ANYWHERE, ANYTIME

We cover all platforms with full synchronization between them!

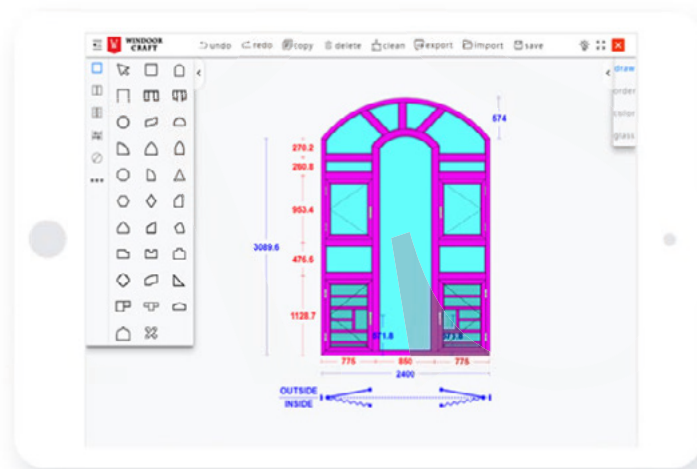
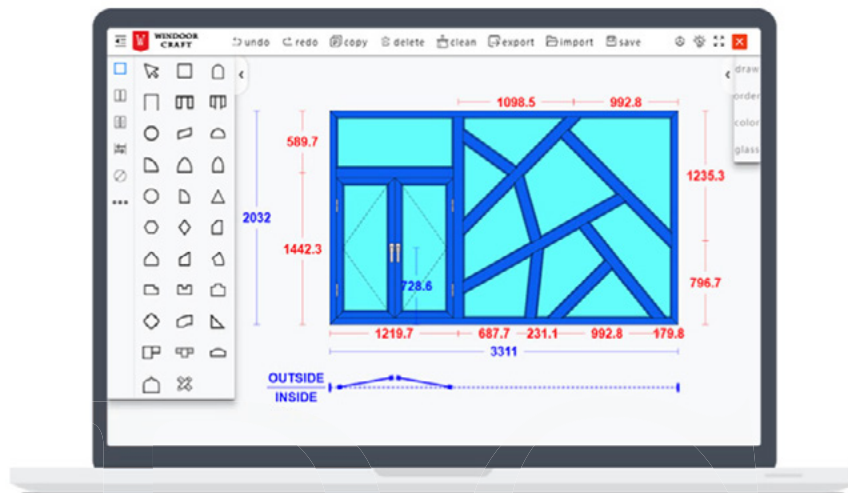

After drawing the windows & doors, we could send the order or project to our clients online.

1. clients could see the window designs and their details.
2. Clients could see the 3d views.
3. Clients could see the quotation.
4. Clients could confirm and sign online.

Fullfill our clients anytime, save cost, outstanding among your competitors!

Please check the link below:

<https://windoorcraft.com/group-detail-share/505385/19879?action=50d2aa150a90b0baa02c52dbbaa60a6f&expire=0&showOrderArea=1&from=1660114298687&lang=en-US>



# BILL OF MATERIALS

AUTOMATICALLY GENERATED REPORTS

## Manufacturing List

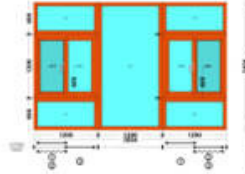

| Stock Code       | Description            | Color | Type      | Angle | QTY | Cut Size | Total |
|------------------|------------------------|-------|-----------|-------|-----|----------|-------|
| <b>Profile</b>   |                        |       |           |       |     |          |       |
| <b>upTrack</b>   |                        |       |           |       |     |          |       |
| MBS-80TLKH3      | 80 Frame               |       | upTrack   | 45-45 | 2   | 1206     | 2412  |
| <b>downTrack</b> |                        |       |           |       |     |          |       |
| MBS-80TLKH3      | 80 Frame               |       | downTrack | 45-45 | 2   | 1206     | 2412  |
| <b>sideTrack</b> |                        |       |           |       |     |          |       |
| MBS-80TLKH3      | 80 Frame               |       | sideTrack | 45-45 | 4   | 1206     | 4824  |
| <b>frame</b>     |                        |       |           |       |     |          |       |
| MBS-80GDKH3      | 80 Fixed Frame         |       | frame     | 45-45 | 8   | 606      | 4848  |
| MBS-80GDKH3      | 80 Fixed Frame         |       | frame     | 45-45 | 10  | 1206     | 12060 |
| MBS-80GDKH3      | 80 Fixed Frame         |       | frame     | 45-45 | 2   | 2410     | 4820  |
| <b>connector</b> |                        |       |           |       |     |          |       |
| MBS-80PB1        | 80 Flat Board          |       | connector | 90-90 | 3   | 1200     | 3600  |
| MBS-80PB1        | 80 Flat Board          |       | connector | 90-90 | 2   | 2404     | 4808  |
| MBS-80PB1        | 80 Flat Board          |       | connector | 90-90 | 1   | 1174     | 1174  |
| <b>fixedBead</b> |                        |       |           |       |     |          |       |
| MBS-80DYB        | 80 Single Glazing Bead |       | fixedBead | 45-45 | 8   | 532      | 4256  |
| MBS-80DYB        | 80 Single Glazing Bead |       | fixedBead | 45-45 | 10  | 1132     | 11320 |
| MBS-80DYB        | 80 Single Glazing Bead |       | fixedBead | 45-45 | 2   | 2336     | 4672  |
| <b>sash</b>      |                        |       |           |       |     |          |       |
| MBS-80TUSD       | 80 Sliding Sash        |       | sash      | 45-45 | 8   | 591.5    | 4732  |
| MBS-80TUSD       | 80 Sliding Sash        |       | sash      | 45-45 | 7   | 1122     | 7854  |
| MBS-80FG         | 80 Interlock           |       | sash      | 90-90 | 3   | 1116     | 3348  |
| <b>sashBead</b>  |                        |       |           |       |     |          |       |
| MBS-80DYB        | 80 Single Glazing Bead |       | sashBead  | 45-45 | 8   | 507.5    | 4060  |
| MBS-80DYB        | 80 Single Glazing Bead |       | sashBead  | 45-45 | 8   | 1038     | 8304  |
| <b>screen</b>    |                        |       |           |       |     |          |       |

1/11

|                 |                                 |  |            |       |     |            |      |
|-----------------|---------------------------------|--|------------|-------|-----|------------|------|
| MBS-42SS        | 80 Screen Sash                  |  | screen     | 45-45 | 4   | 591.5      | 2366 |
| MBS-42SS        | 80 Screen Sash                  |  | screen     | 45-45 | 3   | 1122       | 3366 |
| <b>Hardware</b> |                                 |  |            |       |     |            |      |
| MXNL-PSCG       | Draining Cap                    |  |            |       | 14  |            | 14   |
| MXNL-PZSG       | Decoration Cover                |  |            |       | 80  |            | 80   |
| MXNL-PHL15012   | 80 Sliding Roller               |  |            |       | 8   |            | 8    |
| MXNL-PMT2       | Brush Felt                      |  |            |       | 296 |            | 296  |
| MXNL-PSR        | Screen Roller                   |  |            |       | 4   |            | 4    |
| MXNL-PJTSS      | Screen Bubble Rubber            |  |            |       | 68  |            | 68   |
| MXNL-PYYS19001  | Crescent Lock                   |  |            |       | 2   |            | 2    |
| MXNL-PACB       | Anti Collision Board            |  |            |       | 4   |            | 4    |
| MXNL-PSCC       | Collision Cushion               |  |            |       | 8   |            | 8    |
| MXNL-PWB1       | Windbreak Bridge                |  |            |       | 4   |            | 4    |
| <b>Glass</b>    |                                 |  |            |       |     |            |      |
| 5mm             | Single Glass-F1,F2,F4,F5        |  | fixedGlass |       | 4   | 1124*524   | 2.36 |
| 5mm             | Single Glass-F3                 |  | fixedGlass |       | 1   | 1124*2328  | 2.62 |
| 5mm             | 80 Sash Glass-A1,A2,A3,A4       |  | sashGlass  |       | 4   | 499.5*1030 | 2.06 |
| Screen Mesh Net | MXNL-PSCWBScreen Mesh Net-S1,S2 |  | screenNet  |       | 2   | 565.5*1096 | 1.24 |



**Order no** 2022888-C4  
**Customer** Eric  
**Address** China  
**Total area** 41.73  
**Area** 5.04  
**Product** 60 casement window  
**Count** 1  
**Color** 内(White)/外(White)  
**Size** 2100.00x2400.00  
**Window no** C4

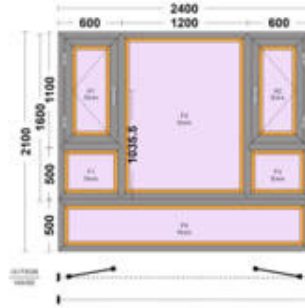

**Note**

| Profile                 |             |        |        |       |           |
|-------------------------|-------------|--------|--------|-------|-----------|
| Name                    | Code        | Color  | Length | Count | Cut angle |
| 60 Frame                | MBS-60PKD   |        | 1606   | 2     | 45-45     |
| 60 Frame                | MBS-60PKD   |        | 2406   | 4     | 45-45     |
| 60 Frame                | MBS-60PKD   |        | 506    | 2     | 45-45     |
| 60 Mullion              | MBS-60ZTD   |        | 1634   | 2     | 45-45     |
| 60 Mullion              | MBS-60ZTD   |        | 656    | 2     | 45-45     |
| 60 Single Glazing Bead  | MBS-60DYA   |        | 1520   | 2     | 45-45     |
| 60 Single Glazing Bead  | MBS-60DYA   |        | 420    | 2     | 45-45     |
| 60 Single Glazing Bead  | MBS-60DYA   |        | 2320   | 2     | 45-45     |
| 60 Single Glazing Bead  | MBS-60DYA   |        | 442    | 4     | 45-45     |
| 60 Single Glazing Bead  | MBS-60DYA   |        | 542    | 4     | 45-45     |
| 60 Single Glazing Bead  | MBS-60DYA   |        | 1164   | 2     | 45-45     |
| 60 Outward Sash         | MBS-60WKCS2 |        | 1028   | 4     | 45-45     |
| 60 Outward Sash         | MBS-60WKCS2 |        | 528    | 4     | 45-45     |
| 60 Switch Frame         | MBS-60ZHK2  |        | 1048   | 4     | 45-45     |
| 60 Switch Frame         | MBS-60ZHK2  |        | 548    | 4     | 45-45     |
| 60 Single Glazing Bead  | MBS-60DYA   |        | 906    | 4     | 45-45     |
| 60 Single Glazing Bead  | MBS-60DYA   |        | 406    | 4     | 45-45     |
| Glass                   |             |        |        |       |           |
| Name                    | Count       | Height | Width  | Note  |           |
| Single Glass-F1,F3      | 2           | 434    | 534    |       |           |
| Single Glass-F2         | 1           | 1512   | 1156   |       |           |
| Single Glass-F4         | 1           | 412    | 2312   |       |           |
| Single Sash Glass-A1,A2 | 2           | 938    | 438    |       |           |
| Addon                   |             |        |        |       |           |

| Name             | Specs | Count | Code           | Note |
|------------------|-------|-------|----------------|------|
| Draining Cap     |       | 8     | MXNL-PSCG      |      |
| Decoration Cover |       | 32    | MXNL-PZSG      |      |
| Handle           |       | 2     | MXNL-PZSW12004 |      |
| Transmission Rod | 600mm | 2     | MXNL-PCX140012 |      |
| Lock Block       |       | 4     | MXNL-POCM11000 |      |
| Wind Stay        | 400mm | 2     | MXNL-PJLW18004 |      |
| Window Hinge     |       | 4     | MXNL-PHY16001  |      |
| Lifting Board    |       | 2     | MXNL-PLB       |      |

# CONFIRM REPORT



Moxisys

2022888

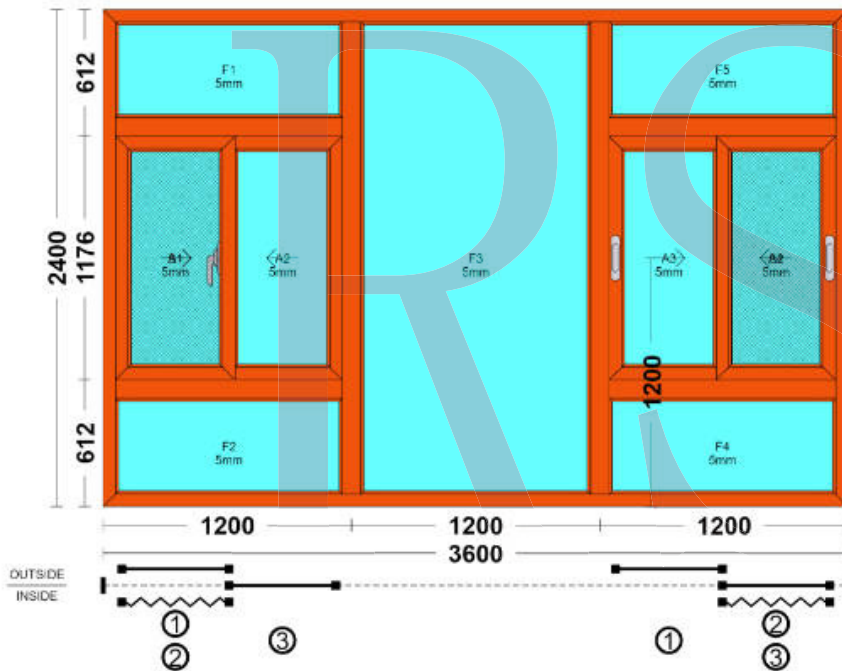

|                         |                           |
|-------------------------|---------------------------|
| <b>Customer</b>         | Eric                      |
| <b>Phone</b>            | 15098928712               |
| <b>Address</b>          | China                     |
| <b>Window no</b>        | C1 1(s)                   |
| <b>Product name</b>     | 80 sliding                |
| <b>Color</b>            | inner(White)/outer(White) |
| <b>Install position</b> | Living Room               |
| <b>Hardware</b>         | Roto Silver               |
| <b>Hardware color</b>   | #D4D1D9                   |
| <b>Glass</b>            | 5mm                       |
| <b>Area</b>             | 8.64                      |
| <b>Designer</b>         |                           |
| <b>Verify</b>           |                           |
| <b>Authorize</b>        |                           |
| <b>Date</b>             |                           |

note: window color according to home design

Customer sign



Solemnly declare:

1. This design can only take effect after being signed and confirmed by the customer.
2. The order will not be modified after 12 hours after signing and confirming the order.
3. If there is any modification, please contact the designer in

# Moxisy confirm report

2022888

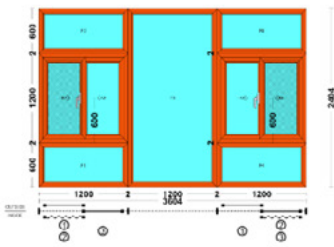

C1 1pcs  
80 sliding window  
Living Room  
5mm  
Roto Silver

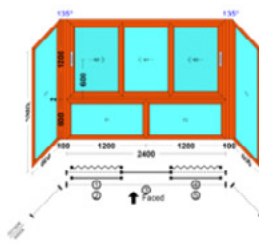

C2 2pcs  
80 sliding window  
Balcony  
5mm  
Golden



C3 1pcs  
60 casement window  
Kitchen  
5mm  
Silver

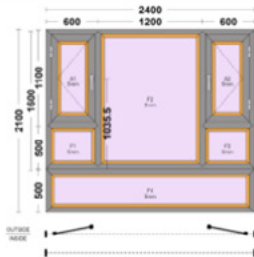

C4 1pcs  
60 casement window  
5mm

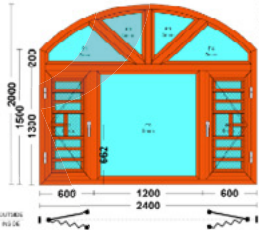

C5 1pcs  
60 casement window  
5mm

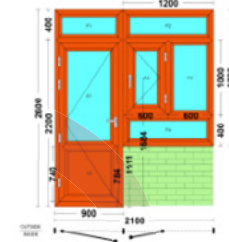

C6 1pcs  
60 casement window  
5mm



Customer

Eric

phone

15098928712

Address

China

Designer

Date



# QUOTATION REPORT



Moxisys

Jinan

Ph:0531-68855401

Email:<https://moxisys.com>

|                             |  |  |   |         |                |
|-----------------------------|--|--|---|---------|----------------|
| C4                          |  | <p>60 casement window</p> <p>Position<br/>2400w * 2100h (5.04Sq.m. / 54.25Sq.Ft.)</p> <p>Frame</p> <p>Color inner(White)/outer(White)</p> <p>Glass 5mm</p> <p>Hardware</p> <p>Weight 37.25</p> <p>Note</p> | 1 | 604.8   | 604.8          |
| C5                          |  | <p>60 casement window</p> <p>Position<br/>2400w * 2000h (4.43Sq.m. / 51.67Sq.Ft.)</p> <p>Frame</p> <p>Color inner(White)/outer(White)</p> <p>Glass 5mm</p> <p>Hardware</p> <p>Weight 34.2</p> <p>Note</p>  | 1 | 531.6   | 531.6          |
| C6                          |  | <p>60 casement window</p> <p>Position<br/>2100w * 2600h (4.5Sq.m. / 58.77Sq.Ft.)</p> <p>Frame</p> <p>Color inner(White)/outer(White)</p> <p>Glass 5mm</p> <p>Hardware</p> <p>Weight 35.38</p> <p>Note</p>  | 1 | 900     | 900            |
| <b>TOTAL</b>                |  |  |   |         | <b>5365.96</b> |
| Total Area:449.19 Sq.Ft.    |  | Sub Total  |   | 5365.96 |                |
| Total Windows:7 Nos         |  | Transportation Charges   |   |         |                |
| Average Price:11.95 /Sq.Ft. |  | CGST @%  |   | 0       |                |
|                             |  | SGST @%  |   | 0       |                |
|                             |  | Grand Total  |   | 5365.96 |                |

Moxisys

Jinan



Tel:0531-68855401

<https://moxisys.com>

QUOTATION

Quotation no:2022888

Customer  
Eric



Telephone  
15098928712

Address  
China

Date  
2022-08-10

All dimensions on drawings are in mm(metric system) and represent rough opening sizes, any other notes in imperial system might not reflect the final production sizes or R.O.(rough opening) sizes and will not be considered valid. All windows and doors are view from inside the house.

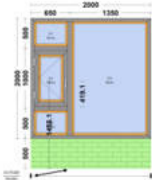
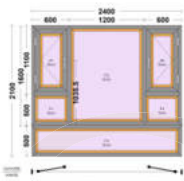
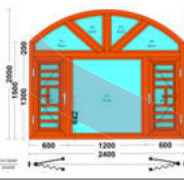
| Item | Quantity | Description  | U.Price/m <sup>2</sup> | Money   |
|------|----------|--|------------------------|---------|
| C1   | 1        |  <p>Product Series: 80 sliding<br/>Material:Thermal break aluminum<br/>Open Style:<br/>I/O Color: White/White<br/>Glass: 5mm<br/>Hardware: Roto Silver<br/>Area: 8.64m<sup>2</sup><br/>Weight: 0</p> | 110.00                 | 942.88  |
| C2   | 2        |  <p>Product Series: 80 sliding<br/>Material:Thermal break aluminum<br/>Open Style:<br/>I/O Color: Black/White<br/>Glass: 5mm<br/>Hardware: Golden<br/>Area: 15.12m<sup>2</sup><br/>Weight: 0</p>    | 120.00                 | 1750.68 |

|    |   |  |        |        |
|----|---|--|--------|--------|
| C3 | 1 |  <p>Product Series: 60 casement window<br/>Material:Thermal break aluminum<br/>Open Style:<br/>I/O Color: White/White<br/>Glass: 5mm<br/>Hardware: Sliver<br/>Area: 4m<sup>2</sup><br/>Weight: 21.99</p> | 150.00 | 636.00 |
| C4 | 1 |  <p>Product Series: 60 casement window<br/>Material:Thermal break aluminum<br/>Open Style:<br/>I/O Color: White/White<br/>Glass: 5mm<br/>Area: 5.04m<sup>2</sup><br/>Weight: 37.25</p>                   | 120.00 | 604.80 |
| C5 | 1 |  <p>Product Series: 60 casement window<br/>Material:Thermal break aluminum<br/>Open Style:<br/>I/O Color: White/White<br/>Glass: 5mm<br/>Area: 4.43m<sup>2</sup><br/>Weight: 34.2</p>                  | 120.00 | 531.60 |
| C6 | 1 |  <p>Product Series: 60 casement window<br/>Material:Thermal break aluminum<br/>Open Style:<br/>I/O Color: White/White<br/>Glass: 5mm<br/>Area: 4.5m<sup>2</sup><br/>Weight: 35.38</p>                  | 200.00 | 900.00 |

# HOW TO USE IT?

Teach you step by step, save your learning cost. Make leaning easier!



**Chapter 1**  
User Login



**Chapter 2**  
Account Setting



**Chapter 3**  
Window Drawing Tools



**Chapter 4**  
Window Design



**Chapter 5**  
Casement Window Drawing



**Chapter 6**  
Sliding Window Drawing



**Chapter 7**  
Turncorner Window Drawing



**Chapter 8**  
Door Drawing



**Chapter 9**  
3D Rendering



**Chapter 10**  
Create Project for Customer



**Chapter 11**  
Create Window Library



**Chapter 12**  
Window Quotation



**Chapter 13**  
Printing & Share



**Chapter 14**  
Add Product Series



**Chapter 15**  
Preset Data



**Chapter 16**  
Material List Template



**Chapter 17**  
Intelligent Quotation & Material List



**Chapter 18**  
Software

# VIDEOS

Teach you step by step, save your learning cost. Make leaning easier!

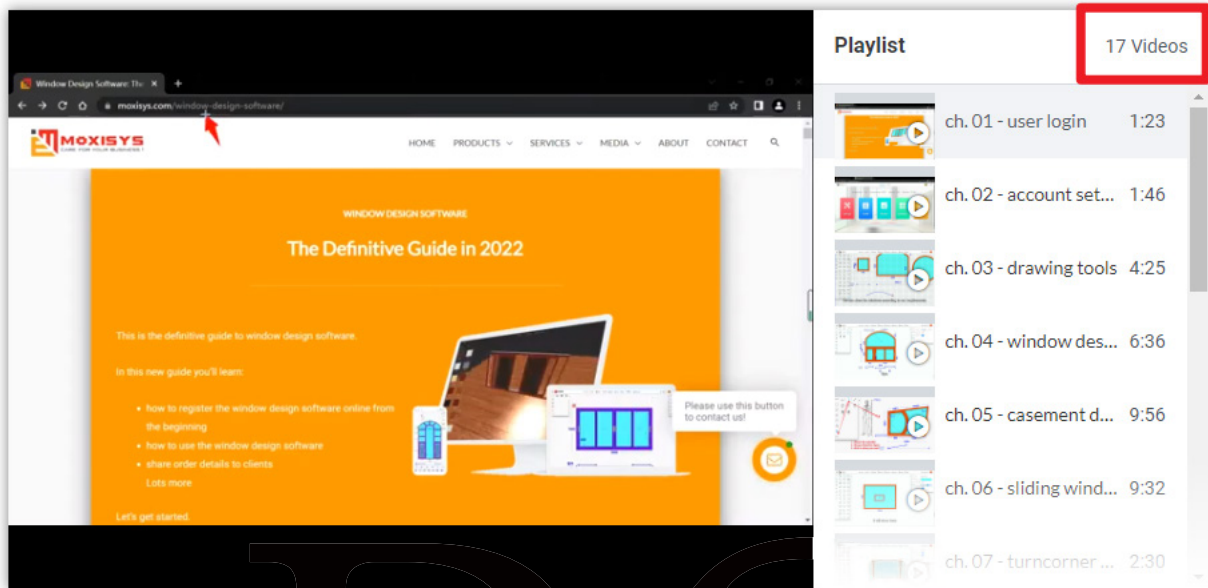

# VERSION COMPARATION

| Design Version  | Pro Version <b>HOT SALE!</b>   | Team Version   |
|---|--|--|
| <ul style="list-style-type: none"><li>➔ One account can be used on computer, tablet and phone simultaneously, data will be synchronized automatically</li><li>➔ design window and door without CAD skill required, casement, sliding and fold are supported</li><li>➔ Arcs, bay and all kinds of non-rectangular window and door</li><li>➔ Arcs, compound and other kinds of non-linear mullions</li><li>➔ Customize window and door</li><li>➔ Generate design and quotation reports</li><li>➔ Share design reports</li><li>➔ Print report and export to PDF file</li><li>➔ Confirm with electronic signature</li></ul> | <ul style="list-style-type: none"><li>➔ One account can be used on computer, tablet and phone simultaneously, data will be synchronized automatically</li><li>➔ design window and door without CAD skill required, casement, sliding and fold are supported</li><li>➔ Arcs, bay and all kinds of non-rectangular window and door</li><li>➔ Arcs, compound and other kinds of non-linear mullions</li><li>➔ Customize window and door</li><li>➔ Generate design and quotation reports</li><li>➔ Share design reports</li><li>➔ Print report and export to PDF file</li><li>➔ Confirm with electronic signature</li><li>➔ Calculate BOM(bill of material)</li><li>➔ Print BOM and certification report etc</li></ul> | <ul style="list-style-type: none"><li>➔ One account can be used on computer, tablet and phone simultaneously, data will be synchronized automatically</li><li>➔ design window and door without CAD skill required, casement, sliding and fold are supported</li><li>➔ Arcs, bay and all kinds of non-rectangular window and door</li><li>➔ Arcs, compound and other kinds of non-linear mullions</li><li>➔ Customize window and door</li><li>➔ Generate design and quotation reports</li><li>➔ Share design reports</li><li>➔ Print report and export to PDF file</li><li>➔ Confirm with electronic signature</li><li>➔ Calculate BOM(bill of material)</li><li>➔ Print BOM and certification report etc</li><li>➔ 20 son accounts</li></ul> |

# WANT A TRIAL?

The trial is free.

Ask to get a free trial!

# PRICE?

Yearly payments and one-time payments.

Choose the better way according to you.





MR. ERIC  
Jinrong Road, Wuxi,  
Jiangsu Prov., China

Phone : +86 150 9892 8712  
WhatsApp : +86 150 9892 8712  
Email : info@moxisys.com

**WWW.MOXISYS.COM**